

产品规格书 Datasheet

目录 Contents

特点 Features

结构 Construction

规格尺寸 Dimensions

负荷下降曲线 Derating Curve

额定值 Ratings

常规 TCR 值

特性 Characteristics

推荐焊盘尺寸 Recommend Solder Pad Size

包装 Packaging

IEC E-24、E-96 系列电阻值代码对照表 Series Resistance Cross-reference List

厚膜电阻阻值代码及标记规则

Description for Resistance Value Code and Marking of Thick Film Chip Resistor

片式电阻器使用说明 Chip Resistor Instructions for Use

厚膜片式电阻

THICK FILM CHIP RESISTOR

特点 Features

体积小、重量轻

Miniature and light weight

适应再流焊与波峰焊

Suitable for reflow and wave flow solder

电性能稳定，可靠性高

Stable electrical capability, high reliability

装配成本低，并与自动贴装设备匹配

Low assembly cost, suitable for automatic SMT equipment

机械强度高，高频特性优越

Superior mechanical and frequency characteristics

符合 RoHS 指令要求

Compliant with RoHS directive

符合无卤素

Halogen free compliant

结构 Construction

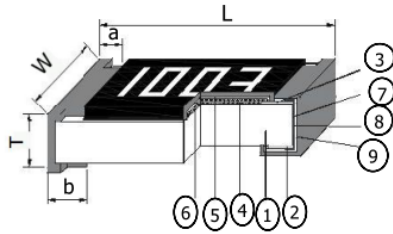

- ① 陶瓷基板 Ceramic Substrate
- ② 背电极 Bottom Electrode
- ③ 面电极 Top Electrode
- ④ 电阻体 Resistor Layer
- ⑤ 一次保护 Primary Overcoat
- ⑥ 二次保护 Secondary Overcoat
- ⑦ 端电极 Edge Electrode
- ⑧ 中间电极 Barrier Layer
- ⑨ 外部电极 External Electrode

规格尺寸 Dimensions

型号 Type	尺寸 Dimensions(mm)				
	L	W	T	a	b
0402	1.00±0.10	0.50±0.10	0.30±0.10	0.20±0.10	0.25±0.10
0603	1.60±0.15	0.80±0.15	0.40±0.10	0.30±0.20	0.30±0.20
0805	2.00±0.20	1.25±0.15	0.50±0.10	0.30±0.20	0.40±0.20
1206	3.20±0.20	1.60±0.15	0.55±0.10	0.50±0.20	0.50±0.20
1210	3.20±0.20	2.60±0.15	0.55±0.10	0.50±0.20	0.50±0.20
1812	4.50±0.20	3.20±0.20	0.55±0.10	0.60±0.20	0.60±0.20
2010	5.00±0.20	2.50±0.15	0.55±0.10	0.60±0.20	0.50±0.20
2512	6.40±0.20	3.20±0.15	0.55±0.10	0.60±0.20	0.50±0.20

负荷下降曲线 Derating Curve

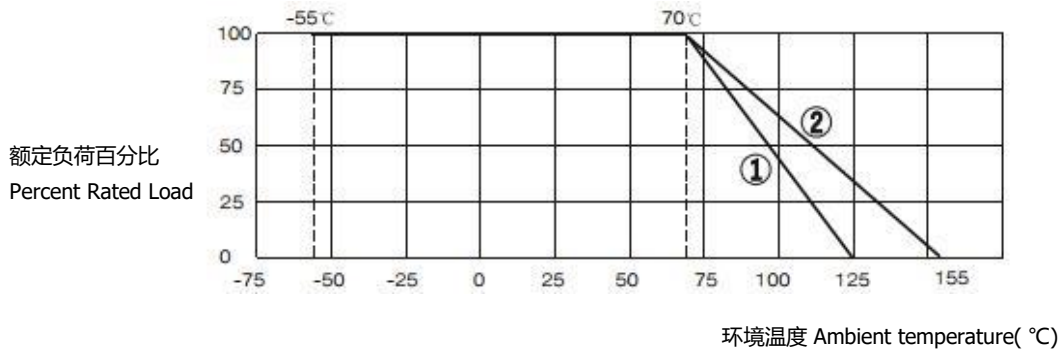

注 1:曲线②适用于 0402、0603、0805、1206、1210、1812、2010、2512 产品。

Note 1: 0402、0603、0805、1206、1210、1812、2010、2512 be the same with curve② .

注 2: 当电阻使用的环境温度超过 70°C时, 其额定负荷 (额定功率) 按上述曲线下降。

Note 2: For resistors operated in ambient over 70°C ,rated load (rated power) shall be derated in accordance with the above derating curve.

标准电气规范

表 1 常规阻值

型 式 Type	定格功率 Rated power	最高使用电压 Maximum working voltage	最高过负荷电压 Maximum overload voltage	阻值范围(Ω) Resistance Range (Ω)				
				±0.1%	±0.5%	±1%	±2%	±5%
0402	1/16W	50V	100V	1 Ω ~ 10M Ω				
0603	1/10W	75V	150V					
0805	1/8W	150V	300V					
1206	1/4W	200V	400V					
1210	1/2W	200V	400V					
1812	3/4W	200V	400V					
2010	3/4W	200V	400V					
2512	1W	200V	400V					

表 2 跨接电阻 (Jumper)

型 式 Type	定格电流 Rated Current	最高过负荷电流 Maximum overload voltage	阻值范围(Ω) Resistance Range (Ω)
0402	1A	2A	±5%: < 50mΩ ±1%: < 30mΩ
0603	1A	2A	
0805	2A	5A	
1206	2A	10A	
1210	2A	10A	
1812	2A	10A	
2010	2A	10A	
2512	2A	10A	

备注:

- ①以上表格中最高使用电压: 按照公式 $E=\sqrt{P \times R}$ 计算出最高工作电压; 当计算的电压小于表-1 中最高使用电压时以计算的电压为准; 当计算的电压大于表-1 中最高使用电压时, 以表-1 中最高使用电压为准。
- ①Note: In the above table top use voltage: according to the formula $E = \sqrt{P \times R}$ calculated the highest working voltage, When calculating the voltage is less than form -1 in the highest use voltage standard as the voltage calculated, When calculating the voltage is greater than the highest voltage of form -1, standard as highest voltage of form -1 .
- ②超出表格规定阻值 10MΩ 以上, 如客户有需求时必须提供相关参数参考, 以利测试。
- ②Beyond the form specified value 10M Ω above, such as customer demand to provide related reference, in order to test.

TCR 值

型号 Type	阻值范围 Resistance Range	电阻温度系数 T.C.R(ppm/ °C)					
		标称阻值允许偏差 Resistance Tolerance					
		±0.1%	±0.25%	±0.5%	±1%	±5%	±10%
0402	1Ω~10MΩ	/	/	/	±200		
0603 0805 1206 1210	1Ω~10Ω	/			±200		
1812 2010 2512	10Ω~10MΩ	/			±100		

特性 Characteristics

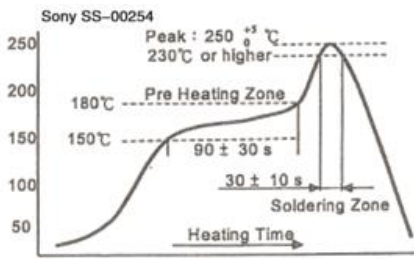
项目 Item	标准 Specifications	测试方法(IEC 60115-1) Test Methods (IEC 60115-1)
可焊性 Solderability	可焊面积≥95% 95% Cover Min	IEC 60115-1 4.17 235°C±5°C 锡槽, 保持 3s±0.5s. Lead-free solder bath at 235°C±5°C for 3s±0.5s.
耐焊接热 Resistance To Soldering Heat	无可见损伤 No mechanical damage $\Delta R \leq \pm (1.0\%R + 0.05 \Omega)$	IEC 60115-1 4.18 270°C±5°C 锡槽, 保持 10s±1s. Lead-free solder bath at 270°C±5°C for 10s±1s.
基板弯曲试验 Substrate Bending Test	无可见损伤 No mechanical damage $\Delta R \leq \pm (1.0\%R + 0.05 \Omega)$	IEC 60115-1 4.33 弯曲距离(Bending distance): 0402:5mm; 0603、0805: 3mm; 1206、1210、1812、2010、2512: 2mm 保持时间(Duration):60s±5s.
电阻温度系数 T.C.R	在规定值内 Within specified T.C.R	IEC 60115-1 4.8 +25°C/-55°C/+25°C/+125°C/+25°C
短时间过负荷 Short Time Overload	0.1%、0.25%、0.5%、1% $\Delta R \leq \pm (1.0\%R + 0.05 \Omega)$ 5%、10% $\Delta R \leq \pm (2.0\%R + 0.05 \Omega)$	IEC 60115-1 4.13 2.5 倍额定电压或最大过负荷电压(取较小值), 保持 5 秒 2.5 times rated voltage or max. overload voltage whichever is lower for 5 s.
回流焊 IR Reflow	无焊接不良	 <p>The graph shows a temperature profile for IR reflow. The y-axis is temperature in °C (50 to 250) and the x-axis is heating time. Key points include: Pre Heating Zone (150°C to 180°C), Soldering Zone (180°C to 250°C), Peak (250°C), and a cooling phase. Time intervals are marked as 90 ± 30 s for the pre-heating zone and 30 ± 10 s for the soldering zone. The source is cited as Sony SS-00254.</p>
耐金属溶出 Leaching	≥95% Coverage	JIS C 520H:260±5°C for 30 seconds
温度快速变化 Thermal Shock	0.1%、0.25%、0.5%、1% $\Delta R \leq \pm (0.5\%R + 0.05 \Omega)$ 5%、10% $\Delta R \leq \pm (1.0\%R + 0.05 \Omega)$	-55°C(30 分钟)--常温(5 分钟)--155°C(30 分钟),300 个循环. -55°C(30min)--normal temperature(5min)--155°C (30min),300 cycles.
耐溶剂 Component Solvent Resistance	无可见损伤 No mechanical damage $\Delta R \leq \pm (1.0\%R + 0.05 \Omega)$	IEC 60115-1 4.29 异丙醇(IPA), 23°C±5°C, 浸 10 小时 Iso-propyl alcohol (IPA), 23°C±5°C, 10h.

特性 Characteristics

项目 Item	标准 Specifications	测试方法(IEC 60115-1) Test Methods (IEC 60115-1)
稳能湿热 Damp Heat, Steady State	0.1%、0.25%、0.5%、1% $\Delta R \leq \pm (1.0\%R + 0.05 \Omega)$ 5%、10% $\Delta R \leq \pm (2.0\%R + 0.05 \Omega)$	IEC 60115-1 4.24 40°C±2°C, 93%±3%RH, 1000 小时, 额定电压或元件极限电压 (取较小值), 通 1.5 小时/断 0.5 小时。 40°C±2°C, 93%±3%RH, 1000h, rated voltage or limiting element Voltage whichever is lower for 1.5h ON/0.5h OFF.
70°C耐久性 Endurance at 70°C	0.1%、0.25%、0.5%、1% $\Delta R \leq \pm (1.0\%R + 0.05 \Omega)$ 5%、10% $\Delta R \leq \pm (2.0\%R + 0.05 \Omega)$	IEC 60115-1 4.25.1 70°C±2°C, 1000 小时, 额定电压或元件极限电压(取较小值), 通 1.5 小时/断 0.5 小时。 70°C±2°C, 1000h, rated voltage or limiting element voltage whichever is lower for 1.5h ON/0.5h OFF.
绝缘电阻 Insulation Resistance	1000MΩ Min	IEC 60115-1 4.6 在电极与基片间施加 100V±15V 直流电压, 保持 1 分钟, 然后测绝缘电阻值。 Apply DC 100V±15V between substrate and terminations for 1min, then check insulation resistance
断续过负载 Intermittent Overload	无可见损伤 No mechanical damage $\Delta R \leq \pm (5.0\%R + 0.05 \Omega)$	IEC 60115-1 4.39 2.5 倍额定电压或最大过负荷电压(取较小值), 通 1 秒/断 25 秒, 10000 个循环。 2.5 times rated voltage or max. overload voltage whichever is lower for 1s ON/ 25s OFF ,10000 cycles.
剪切力试验 Shear Test	外观无可见损伤 No mechanical damage	IEC 60115-1 4.32 施加力(Applying force): 0402、0603: 5N 0805: 9N; 1206、1210: 25N; 2010、1812、2512: 45N 保持时间(Duration): 10s±1s.
耐电压 Voltage Proof	无击穿或飞弧 No breakdown or flashover	IEC 60115-1 4.7 在电极与基片间施加 100V 交流电压, 保持 1 分钟 Apply AC 100V between substrate and terminations for 1min

推荐焊盘尺寸 Recommend Solder Pad Size

片式固定电阻器 Chip fixed resistor

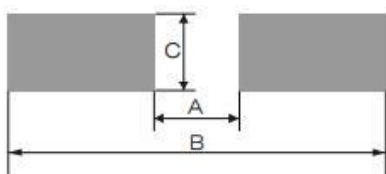

型别 type	A	B	C
0402	0.41	1.43	0.64
0603	0.82	2.86	1.19
0805	0.97	3.51	1.40
1206	1.90	4.50	1.75
1210	1.90	4.50	3.00
1812	2.50	7.50	3.70
2010	2.65	7.75	3.00
2512	3.40	10.00	3.70

包装 Packaging

纸带尺寸 Tape Specification

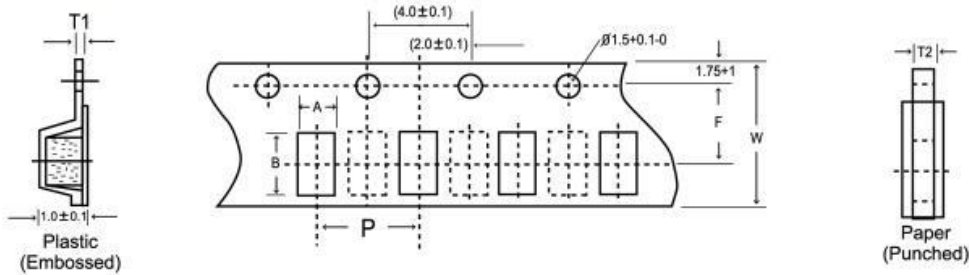

Size Code	A	B	W	F	T1	T2	P
0402	0.65±0.05	1.20±0.1	8.0±0.2	3.5±0.05	/	0.45±0.1	2.0±0.1
0603	1.10±0.1	1.90±0.1	8.0±0.2	3.5±0.05	/	0.60±0.1	4.0±0.1
0805	1.65±0.2	2.40±0.2	8.0±0.2	3.5±0.05	/	0.75±0.1	4.0±0.1
1206	2.00±0.2	3.60±0.2	8.0±0.2	3.5±0.05	/	0.75±0.1	4.0±0.1
1210	2.80±0.2	3.50±0.2	8.0±0.2	3.5±0.05	/	0.75±0.1	4.0±0.1
1812	3.60±0.2	5.00±0.2	12.0±0.2	5.5±0.05	0.2±0.05	1.0±0.1	4.0±0.1
2010	2.90±0.2	5.50±0.2	12.0±0.2	5.5±0.05	0.2±0.05	1.0±0.1	4.0±0.1
2512	3.60±0.2	6.90±0.2	12.0±0.2	5.5±0.05	0.2±0.05	1.0±0.1	4.0±0.1

卷盘 Reel

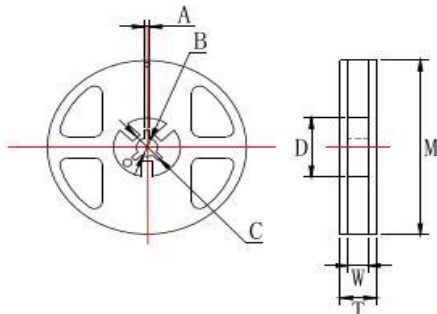

型号 Type	M	W	T	A	B	C	D
0402、0603	178±2.0	9.5±1.0	12.5±1.5	2.0±0.5	13.0±0.5	21.0±0.5	58.0±2.0
0805、1206、1210							
1812、2010、2512		12.5±1.0	15.0±1.5	3.0±0.5			

包装数量 Packaging Quantity

包装方法 Packaging style	编带 Tape & reel			塑料袋散装 Case		
型号 Type	0402	0603 0805 1206 1210	1812、2010 2512	0402	0603 0805 1206 1210	1812 2010 2512
数量 Quantity(pcs)	10000	5000	4000	≤50000	≤10000	≤4000

Operation and Storage Temperature 工作和储存温度

	MIN	MAX
Normal Operate Temperature 正常工作温度	-55°C	70°C
Storage Temperature 储存温度	5°C	30°C
Storage Humidity 储存湿度	40%	80%
Shelf Life 保存期限	2 Years 2 年	

IEC E-24、E-96 系列电阻值代码对照表 Series Resistance Cross-reference List

E-24 系列 E-24 series($\times 10^n \Omega$)

(单位 unit: 0.001 Ω 、0.01 Ω 、0.1 Ω 、1 Ω 、10 Ω 、100 Ω 、1k Ω 、10k Ω 、100k Ω 、1M Ω 、10M Ω 、100M Ω 、1000M Ω)

1.0	1.5	2.2	3.3	4.7	6.8
1.1	1.6	2.4	3.6	5.1	7.5
1.2	1.8	2.7	3.9	5.6	8.2
1.3	2.0	3.0	4.3	6.2	9.1

E-96 系列 E-96 series($\times 10^n \Omega$)

(单位 unit: 0.001 Ω 、0.01 Ω 、0.1 Ω 、1 Ω 、10 Ω 、100 Ω 、1k Ω 、10k Ω 、100k Ω 、1M Ω 、10M Ω 、100M Ω 、1000M Ω)

1.00	1.33	1.78	2.37	3.16	4.22	5.62	7.50
1.02	1.37	1.82	2.43	3.24	4.32	5.76	7.68
1.05	1.40	1.87	2.49	3.32	4.42	5.90	7.87
1.07	1.43	1.91	2.55	3.40	4.53	6.04	8.06
1.10	1.47	1.96	2.61	3.48	4.64	6.19	8.25
1.13	1.50	2.00	2.67	3.57	4.75	6.34	8.45
1.15	1.54	2.05	2.74	3.65	4.87	6.49	8.66
1.18	1.58	2.10	2.80	3.74	4.99	6.65	8.87
1.21	1.62	2.15	2.87	3.83	5.11	6.81	9.09
1.24	1.65	2.21	2.94	3.92	5.23	6.98	9.31
1.27	1.69	2.26	3.01	4.02	5.36	7.15	9.53
1.30	1.74	2.32	3.09	4.12	5.49	7.32	9.76

E-96 系列 0603 型号《乘数代码对照表》

E-96 series(0603) 《multiplied Cross-reference List》

乘数 multiplied	$\times 10^0$	$\times 10^1$	$\times 10^2$	$\times 10^3$	$\times 10^4$	$\times 10^5$	$\times 10^6$	$\times 10^7$	$\times 10^{-1}$	$\times 10^{-2}$	$\times 10^{-3}$
代码 code	A	B	C	D	E	F	G	H	X	Y	Z

E-96 系列 0603 型号《电阻值代码对照表》

E-96 series(0603) 《Resistance Cross-reference List》

代号 Code	E-96 系列电阻 E-96 resistance	代号 Code	E-96 系列电阻 E-96 resistance	代号 Code	E-96 系列电阻 E-96 resistance	代号 Code	E-96 系列电阻 E-96 resistance
01	100	25	178	49	316	73	562
02	102	26	182	50	324	74	576
03	105	27	187	51	332	75	590
04	107	28	191	52	340	76	604
05	110	29	196	53	348	77	619
06	113	30	200	54	357	78	634
07	115	31	205	55	365	79	649
08	118	32	210	56	374	80	665
09	121	33	215	57	383	81	681
10	124	34	221	58	392	82	698
11	127	35	226	59	402	83	715
12	130	36	232	60	412	84	732
13	133	37	237	61	422	85	750
14	137	38	243	62	432	86	768
15	140	39	249	63	442	87	787
16	143	40	255	64	453	88	806
17	147	41	261	65	464	89	825
18	150	42	267	66	475	90	845
19	154	43	274	67	487	91	866
20	158	44	280	68	499	92	887
21	162	45	287	69	511	93	909
22	165	46	294	70	523	94	931
23	169	47	301	71	536	95	953
24	174	48	309	72	549	96	976

厚膜电阻阻值代码及标记规则

Description for Resistance Value Code and Marking of Thick Film Chip Resistor

阻值代码 Resistance Value Code

所有厚膜电阻的阻值代码与其标记是相对应的

All the resistance value code of thick film chip resistor is corresponding with the marking .

标记 Marking

E-24 系列（0603、±5%）：采用三位数表示，前二位表示电阻值有效数字，第三位表示乘以 10 的次方数。

E-24 series: Express resistance value on the glass side with three digits, the first tow digits should be significant and the third one denote number of zeros.

例 For example:



E-24 系列（0603、±1%&±0.5%）：在三位数字标记下方增加下划线识别

E-24 series(0603、 ±1%&± 0.5%): One short bar under marking letter.

例 For example:



E-96 系列和 E24 系列（±1%&±0.5%）：

0805、1206、1210、2010、2512、4R02、4R03 采用四位数字表示，前三位表示电阻值有效数字，第四位表示乘以 10 的次方数。

E-96 series & E-24 series: For the dimension type of 0805、1206、1210、2010、2512、4R02、4R03 express the resistance value with four digits, the first three digits are significant figures and the fourth denotes the number of zeros.

例 For example:

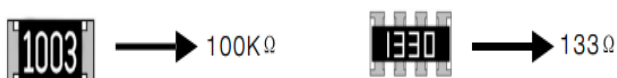

E-96 系列

0603 用三位代码表示，前二位表示 E-96 系列阻值代码，后一位字母表示乘数代码。

For the dimension type of 0603, express the resistance value with three code, the first two digit code denote the resistance of E-96 series, and the third code of letter denote the multiplier.

例 For example:

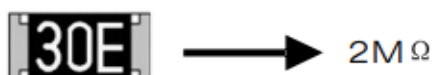

小数点以“R”表示 The decimal point should be expressed by “R” .

例 For example:



跨接电阻以“0”表示 The jumper should be expressed by “0”.

例 For example:



0201、0402 不作标记

For the dimension type of 0201、0402 there is no mark on the glass side.

例 For example:



非 IEC 标准系列的电阻值标记表示方法：一般以最接近 IEC E24 系列标称阻值的标记表示方法。

For the resistance which don't belong to IEC serial, use the resistance of IEC serial which is most close to the required resistance of non-IEC serial for replacement.

客户对标记有特殊要求时，则按照协商的结果印刷标记。

To get agreement by both party if there special requirement for the marking.

阻值代码与实际阻值的对应关系

Resistance rule of global part number	
Resistance coding rule	Example
XRXX (1 to 9.76 Ω)	1R = 1 Ω 1R5 = 1.5 Ω 9R76 = 9.76 Ω
XXRX (10 to 97.6 Ω)	10R = 10 Ω 97R6 = 97.6 Ω
XXXR (100 to 976 Ω)	100R = 100 Ω
XKXX (1 to 9.76 KΩ)	1K = 1,000 Ω 9K76 = 9760 Ω
XMXX (1 to 9.76 MΩ)	1M = 1,000,000 Ω 9M76 = 9,760,000 Ω

片式电阻器使用说明 Chip Resistor Instructions for Use

本产品以下特殊环境下应用，性能可能会受到影响：

- 1、在各种类型的液体，包括水、油、化学品、有机溶剂的使用。
- 2、在户外直接暴露在阳光的地方，或在灰尘多的地方使用。
- 3、在产品暴露的地方，有海风或腐蚀性气体，包括氯气、硫化氢、氨气、二氧化硫、二氧化氮等。
- 4、在产品暴露于静电或电磁波的地方使用。
- 5、在产生热量的部件、塑料线或其它易燃物品附近使用。
- 6、在用树脂或其他涂层材料密封产品的情况下使用。
- 7、焊接后使用不洁焊料或使用水或水溶性清洗剂清洗产品。

Application of the products in a special environment can deteriorate product performance:

- 1、 Use in various types of liquid, including water, oils, chemicals, and organic solvents.
- 2、 Use outdoors where the products are exposed to direct sunlight, or in dusty places.
- 3、 Use in places where the products are exposed to sea winds or corrosive gases, including Cl_2 , H_2S , NH_3 , SO_2 , and NO_2 etc.
- 4、 Use in places where the products are exposed to static electricity or electromagnetic waves.
- 5、 Use in proximity to heat-producing components, plastic cords, or other flammable items.
- 6、 Use involving sealing or coating the products with resin or other coating materials.
- 7、 Use involving unclean solder or use of water or water-soluble cleaning agents for cleaning after soldering.

产品使用注意事项

- 1、避免采用超过正常额定功率的功率，超过额定功率的稳能负载条件下可能会对产品性能和可靠性产生负面影响。
- 2、用镊子拿起产品时要小心，有可能会将保护或电阻体夹碎。

- 3、手动安装产品时，烙铁头勿触碰产品。。

Precautions on use of products

- 1、 Avoid applying power exceeding normal rated power, exceeding the power rating under steady-state loading condition may negatively affect product performance and reliability.
- 2、 Be careful when pick up the products with tweezers. There may be a care that the overcoat or the body can be chipped.
- 3、 Soldering tip shall not touch the product when install product manually.

NOTICE

The information presented in this document is for reference only. Involving product optimization and productivity improvement, ChipNobo reserves the right to adjust product indicators and upgrade some technical parameters. ChipNobo is entitled to be exempted from liability for any delay or non-delivery of the information disclosure process that occurs.

本文件中提供的信息仅供参考。涉及产品优化和生产效率改善，ChipNobo 有权调整产品指标和部分技术参数的升级，所出现信息披露过程存在延后或者不能送达的情形，ChipNobo 有获免责权。

The product listed herein is designed to be used with residential and commercial equipment, and do not support sensitive items and specialized equipment in areas where sanctions do exist. ChipNobo Co., Ltd or anyone on its behalf, assumes no responsibility or liability for any damages resulting from improper use.

此处列出的产品旨在民用和商业设备上使用，不支持确有制裁地区的敏感项目和特殊设备，ChipNobo 有限公司或其代表，对因不当使用而造成的任何损害不承担任何责任。

For additional information, please visit our website <https://www.chipnobo.com/en> or consult your nearest Chipnobo sales office for further assistance.

欲了解更多信息，请访问我们的网站 <https://www.chipnobo.com/en>，或咨询离您最近的 Chipnobo 销售办事处以获得进一步帮助。