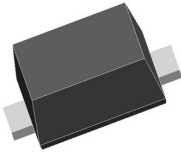
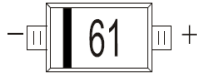

SOD-523

MARKING: 61

特征 Features

- 开关速度小于 4.0nS; Fast Switching Device (TRR <4.0 nS)
- 最大功率耗散 150mW; Power Dissipation of 150mW
- 高稳定性和可靠性。High Stability and High Reliability
- 反向漏电流小。Low reverse leakage

机械数据 Mechanical Data

- 封装: SOD-523 封装 SOD-523 Small Outline Plastic Package
- 极性: 色环端为负极 Polarity: Color band denotes cathode end
- 安装位置: 任意 Mounting Position: Any

极限值和温度特性(TA = 25°C 除非另有规定)

Maximum Ratings & Thermal Characteristics (Ratings at 25°C ambient temperature unless otherwise specified.)

参数 Parameters	符号 Symbol	数值 Value	单位 Unit
反向电压 Reverse Voltage	V _R	75	V
反向工作电压 Working Inverse Voltage	W _{IV}	75	V
反向峰值电压 Peak Reverse Voltage	V _{RM}	100	V
功率消耗 Power Dissipation	P _d	150	mW
工作结温 Operating junction temperature	T _j	150	°C
存储温度 Storage temperature range	T _s	-55-+150	°C
热阻 Thermal Resistance from Junction to Ambient	R _{θJA}	833	°C/W
平均整流电流 Average Rectified Current	I _O	250	mA
正向(不重复)浪涌电流 Peak Forward Surge Current @tp=1us; TA=25°C	I _{FSM}	2.0	A

Valid provided that electrodes are kept at ambient temperature.

电特性 Electrical Characteristics (Ratings at 25°C ambient temperature unless otherwise specified).

符号 Symbols	参数 Parameter	测试条件 Test Condition	界限 Limits		单位 Unit
			Min	Max	
BV	反向击穿电压	IR=100uA	75		V
IR	反向漏电流 Reverse Leakage Current	VR=25V	---	30	nA
		VR=75	---	1	uA
VF	正向电压 Forward Voltage	IF=1.0mA	---	0.715	V
		IF=10mA	---	0.855	
		IF=50mA	---	1.00	
		IF=150mA	---	1.25	
TRR	反向恢复时间 Reverse Recovery Time	IF= IR=10mA RL=100Ω IRR=0.1 X IR	---	4	nS
CT	结电容 Capacitance	VR=0V, f=1MHZ	---	1	pF

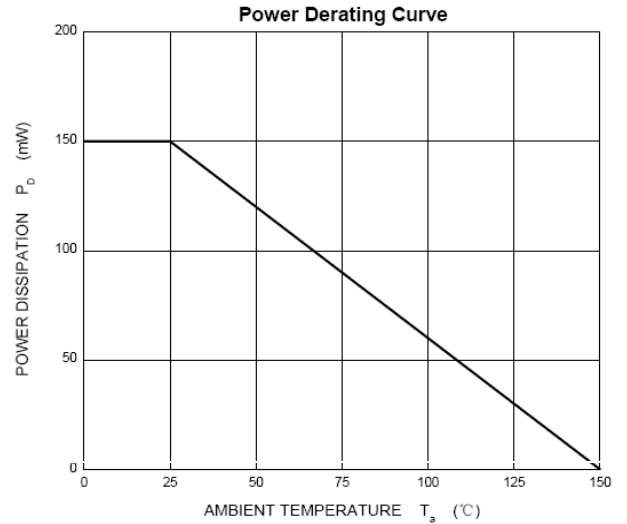
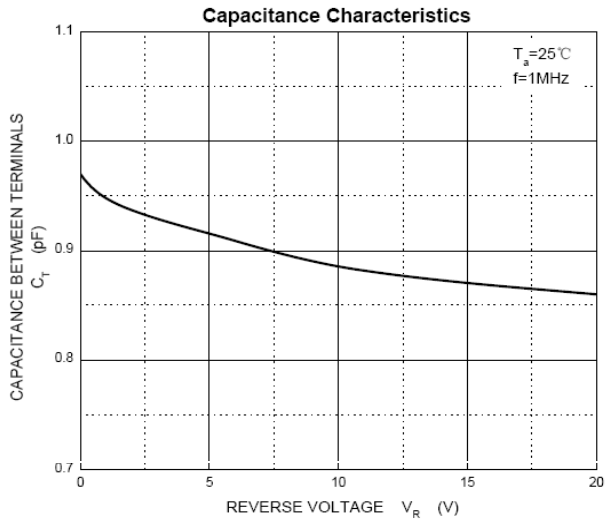
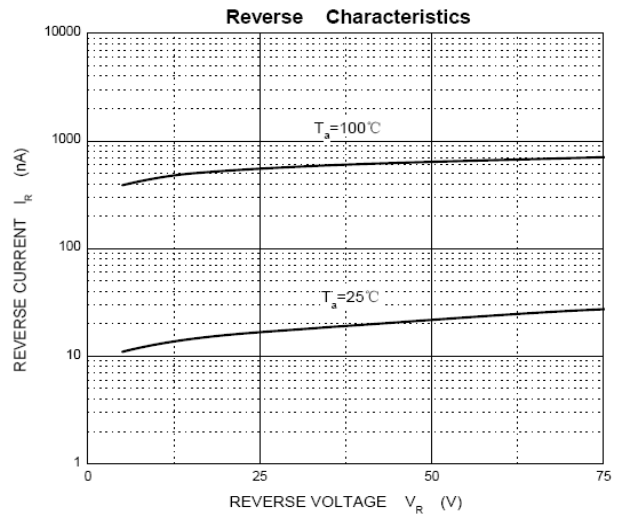
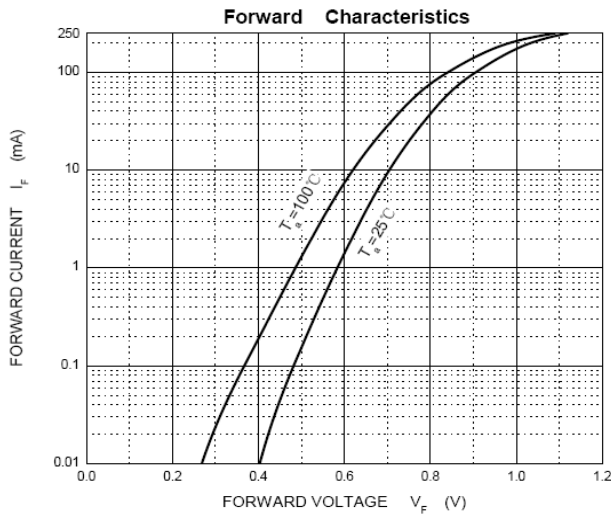

SOD-523 PACKAGE OUTLINE

Plastic surface mounted package

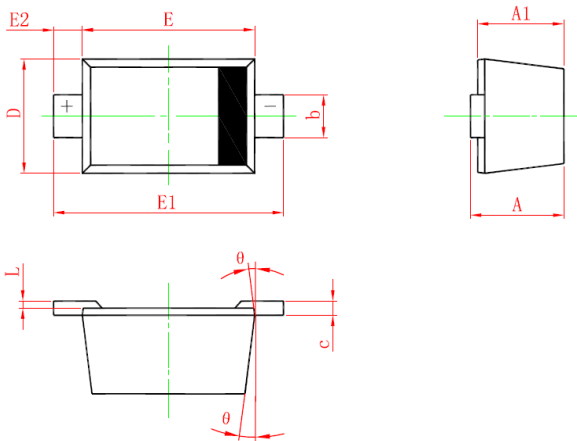

Symbol	Dimensions In Millimeters		Dimensions In Inches	
	Min	Max	Min	Max
A	0.510	0.770	0.020	0.031
A1	0.500	0.700	0.020	0.028
b	0.250	0.380	0.010	0.015
c	0.080	0.150	0.003	0.006
D	0.750	0.850	0.030	0.033
E	1.100	1.300	0.043	0.051
E1	1.500	1.700	0.059	0.067
E2	0.200 REF		0.008 REF	
L	0.010	0.070	0.001	0.003
θ	7° REF		7° REF	

NOTICE

The information presented in this document is for reference only. Involving product optimization and productivity improvement, ChipNobo reserves the right to adjust product indicators and upgrade some technical parameters. ChipNobo is entitled to be exempted from liability for any delay or non-delivery of the information disclosure process that occurs.

本文件中提供的信息仅供参考。涉及产品优化和生产效率改善，ChipNobo 有权调整产品指标和部分技术参数的升级，所出现信息披露过程存在延后或者不能送达的情形，ChipNobo 有获免责权。

The product listed herein is designed to be used with residential and commercial equipment, and do not support sensitive items and specialized equipment in areas where sanctions do exist. ChipNobo Co., Ltd or anyone on its behalf, assumes no responsibility or liability for any damages resulting from improper use.

此处列出的产品旨在民用和商业设备上使用，不支持确有制裁地区的敏感项目和特殊设备，ChipNobo 有限公司或其代表，对因不当使用而造成的任何损害不承担任何责任。

For additional information, please visit our website <http://www.chipnobo.com>, or consult your nearest Chipnobo sales office for further assistance.

欲了解更多信息，请访问我们的网站 <http://www.chipnobo.com>，或咨询离您最近的 Chipnobo 销售办事处以获得进一步帮助。